

*disinfection system*  
dezenfeksiyon sistemleri

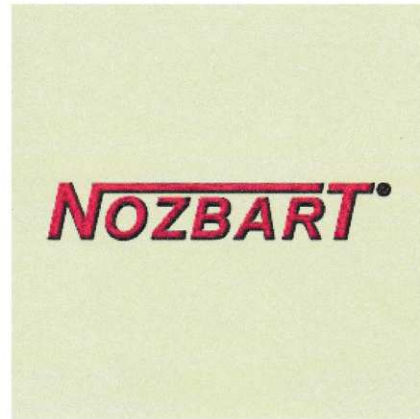

2013  
Fiyat Listesi-Price List  
2014



dezenfeksiyon sistemleri  
*disinfection systems***NOZBART®****ULTRAVİYOLE İLE DEZENFEKSİYON SİSTEMLERİ**

- Klor ve diğer havuz kimyasallarının kullanımını %80'e varan oranda azaltır  
*Reduces the usage of chlorine and other chemicals by up to 80%*
- Göz kızarması ve cilt tahrişine sebep olmaz  
*No red eyes or skin irritation*
- Kimyasallar gibi alerji ve astıma neden olmaz  
*Not causing allergies and asthma as other chemicals do*
- Klor gazı ve kokusuna son verir  
*No chlorine gas and smells anymore*
- Düşük kimyasal, enerji ve bakım maliyeti ile tasarruf sağlar  
*Lower cost in chemicals, energy and maintenance*
- Yüksek su kalitesi, temiz ve taze havuz suyu  
*Improved water clarity, clean and fresh water*
- P316 Paslanmaz çelik gövde  
*P316 L Stainless-Steel body*

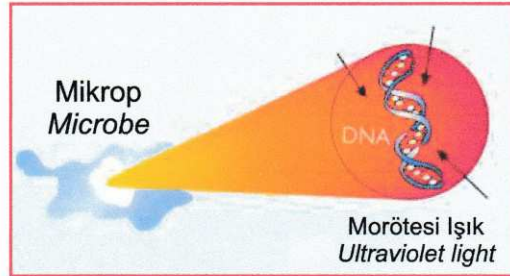
**% 80 daha az CL**  
**Up to 80 % less CL**

DNA'nın moleküler yapısı parçalanır  
ve mikrop zararsız hale gelir

*The molecular structure of the DNA is broken down  
rendering the microbe harmless*

MALZEME CİNSİ DESCRIPTON	KOD NO CODE NO	FİYATI (€) PRICE	AMBALAJ PACKAGE
Blue Lagoon UV-C Tech 15.000 / 16 Watt (230 V - 50/60 Hz)	B900000	<b>415,00</b>	1 ADET 1 UNIT
Blue Lagoon UV-C Tech 40.000 / 40 Watt (230 V - 50/60 Hz)	B900001	<b>575,00</b>	1 ADET 1 UNIT
Blue Lagoon UV-C Tech 75.000 / 75 Watt (230 V - 50/60 Hz)	B900002	<b>620,00</b>	1 ADET 1 UNIT
Blue Lagoon UV-C Amalgam 150.000 / 1	B210004	<b>1265,00</b>	1 ADET 1 UNIT
Lamba / Lamp TUV Tech 4P-SE T5 (75 Watt)	B910001	<b>121,00</b>	1 ADET 1 UNIT

**NOZBART®**

dezenfeksiyon sistemleri  
*disinfection systems*

- N Lamba Kapağı / Cap
- L Lamba Duyu / Lamp Holder
- K Lamba / Lamp
- P Contalar / Seals
- M Kuvars Cam / Quartz Glass
- J U-PVC Boru / U-PVC Pipe
- I Üç Parçalı Rakor / Three-part Couplings
- O Tesbit Kelepçesi / Pipe Clips

\* Lütfen fiyat sorunuz.

\* Please consult us.

SPA & POOL UV-15.000



SPA & POOL  
UV-(40.000-75.000-150.000)

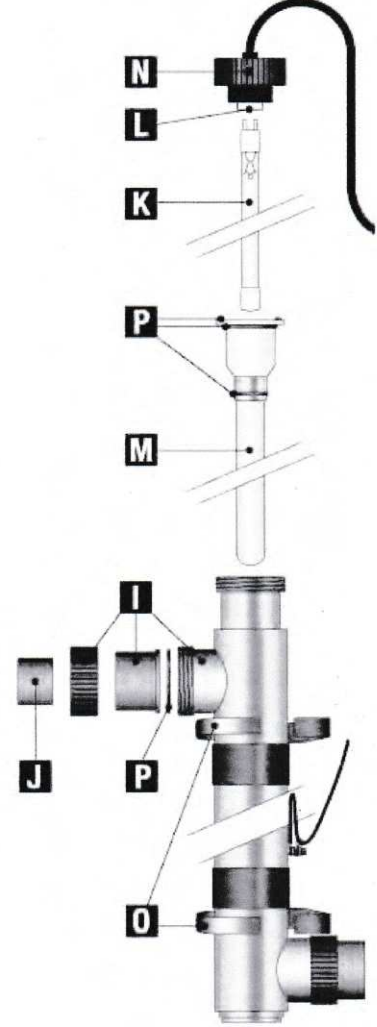
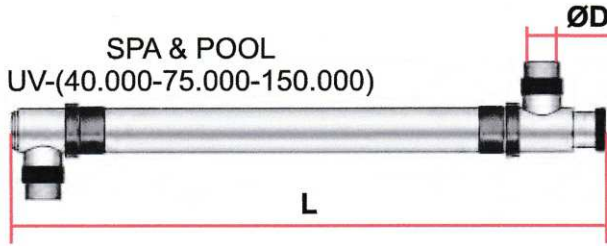

Model	UV-C 15.000 / 16W	UV-C 40.000 / 40W	UV-C 75.000 / 75W	UV-C 150.000 / 130W
Havuz / SPA Hacmi Pool / SPA Volume	15.000 lt.	40.000 lt.	75.000 lt.	150.000 lt.
UV Lamba UV Lamp	Lamp TUV Tech 4P-SE T5 (16 Watt)	Lamp TUV Tech 4P-SE T5 (40 Watt)	Lamp TUV Tech 4P-SE T5 (75 Watt)	Lamp TUV Amalgam (130 Watt)
UV Işıma UV Radiation	3,9 Watt UV	15 Watt UV	25 Watt UV	50 Watt UV
9.000 saatten sonra UV Işıma UV-C (%) After 9.000 hours	% 75	% 85	% 80	% 80
Maksimum Debi Max. Flow	7.200 lt / Saat (Hour)	20.000 lt / Saat (Hour)	25.000 lt / Saat (Hour)	30.000 lt / Saat (Hour)
Maksimum Basınç Max. Pressure	3 BAR	3 BAR	3 BAR	3 BAR
Uzunluk L Length L	56 cm	100 cm	100 cm	100 cm
Bağlantı D Connection D	63 mm	63 mm	63 mm	63 mm

dezenfeksiyon sistemleri  
*disinfection systems*

**NOZBART®**

**NOZBART KLORİNATÖR**  
**NOZBART CHLORINATOR**



MALZEME CİNSİ DESCRIPTION	KOD NO: CODE NO:	FİYATI (€) PRICE	AĞIRLIK WEIGHT	AMBALAJ PACKAGE
2" Klorinatör (Otomatik klorlama cihazı) (6 kg. tablet klor kapasitelidir.) 2" Chlorinator (Automatic chlorine feeder) (Capacity 6 kg. chlorine tablets)	KLR-063	<b>82,80</b>	3.100 gr.	1 ADET 1 UNIT

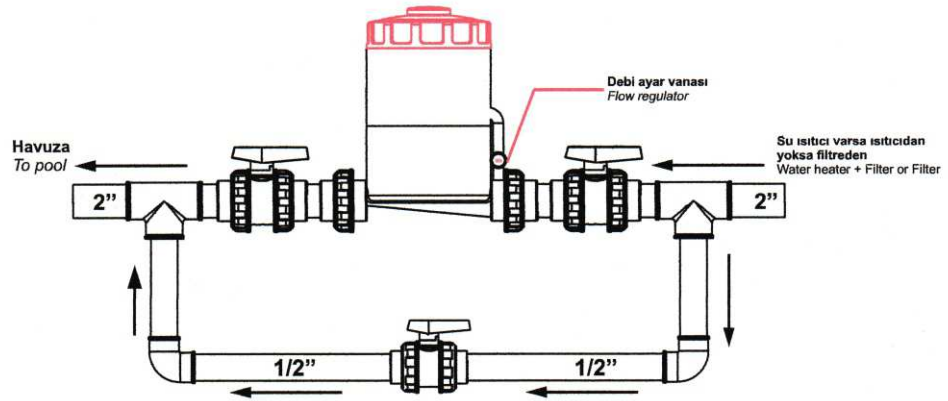

**NOZBART DOZAJ POMPALARI**  
**NOZBART DOSING PUMPS**



MALZEME CİNSİ DESCRIPTION	KOD NO: CODE NO:	FİYATI (€) PRICE	AMBALAJ PACKAGE
2 litre / 10 bar Nozbart dozaj pompası 2 litre / 10 bar Nozbart dosing pump	NDP-0210	<b>185,00</b>	1 ADET 1 UNIT
2 litre / 20 bar Nozbart dozaj pompası 2 litre / 20 bar Nozbart dosing pump	NDP-0216	<b>269,00</b>	1 ADET 1 UNIT
5 litre / 7 bar Nozbart dozaj pompası 5 litre / 7 bar Nozbart dosing pump	NDP-0507	<b>185,00</b>	1 ADET 1 UNIT
10 litre / 5 bar Nozbart dozaj pompası 10 litre / 5 bar Nozbart dosing pump	NDP-1005	<b>252,00</b>	1 ADET 1 UNIT
10 litre / 10 bar Nozbart dozaj pompası 10 litre / 10 bar Nozbart dosing pump	NDP-1010	<b>269,00</b>	1 ADET 1 UNIT
20 litre / 5 bar Nozbart dozaj pompası 20 litre / 5 bar Nozbart dosing pump	NDP-2005	<b>286,00</b>	1 ADET 1 UNIT

**NOZBART®**dezenfeksiyon sistemleri  
*disinfection systems***NOZBART DIJİTAL DOZAJ POMPALARI**  
**NOZBART DIGITAL DOSING PUMPS**

MALZEME CİNSİ DESCRIPTON	KOD NO: CODE NO:	FİYATI (€) PRICE	AMBALAJ PACKAGE
2 litre / 10 bar Nozbart dijital dozaj pompası 2 litre / 10 bar Nozbart digital dosing pump	DDP-0210	243,60	1 ADET 1 UNIT
5 litre / 7 bar Nozbart dijital dozaj pompası 5 litre / 7 bar Nozbart digital dosing pump	DDP-0507	243,60	1 ADET 1 UNIT
2 litre / 20 bar Nozbart dijital dozaj pompası 2 litre / 20 bar Nozbart digital dosing pump	DDP-0216	327,60	1 ADET 1 UNIT
10 litre / 5 bar Nozbart dijital dozaj pompası 10 litre / 5 bar Nozbart digital dosing pump	DDP-1005	310,80	1 ADET 1 UNIT
10 litre / 10 bar Nozbart dijital dozaj pompası 10 litre / 10 bar Nozbart digital dosing pump	DDP-1010	327,60	1 ADET 1 UNIT
20 litre / 5 bar Nozbart dijital dozaj pompası 20 litre / 5 bar Nozbart digital dosing pump	DDP-2005	344,40	1 ADET 1 UNIT

**NOZBART NANO DOZAJ POMPALARI**  
**NOZBART NANO DOSING PUMPS**

MALZEME CİNSİ DESCRIPTON	KOD NO: CODE NO:	FİYATI (€) PRICE	AMBALAJ PACKAGE
5 litre / 5 bar Nozbart Nano dozaj pompası 5 litre / 5 bar Nozbart Nano dosing pump	NAN-0505	161,50	1 ADET 1 UNIT
2 litre / 10 bar Nozbart Nano dozaj pompası 2 litre / 10 bar Nozbart Nano dosing pump	NAN-0210	161,50	1 ADET 1 UNIT

**DOZAJ POMPASI SEÇİM TABLOSU**  
**DOSING PUMP SELECTION TABLE**

Havuz Büyüklüğü Pool Size	CL Dozaj Pompası CL Dosing Pump	PH Dozaj Pompası PH Dosing Pump
0 - 250 m <sup>3</sup>	2 litre / 10 Bar	2 litre / 10 Bar
250 - 450 m <sup>3</sup>	5 litre / 7 Bar	5 litre / 7 Bar
450 - 750 m <sup>3</sup>	10 litre / 5 Bar	10 litre / 5 Bar
750 - 1200 m <sup>3</sup>	20 litre / 5 Bar	10 litre / 5 Bar
1200 -1700 m <sup>3</sup>	20 litre / 5 Bar	20 litre / 5 Bar

dezenfeksiyon sistemleri  
*disinfection systems*

**NOZBART®**

### OTOMATİK KONTROL 03 *AUTOMATIC CONTROL 03*

YÜZME HAVUZU OTOMATİK KONTROL SİSTEMLERİ DOZAJ POMPALI  
*SWIMMING POOL AUTOMATIC CONTROL SYSTEMS WITH DOSING PUMPS*

- ◆ 60 X 45 cm panel üzerinde bağlantı elamanları monte edilmiş halde  
*All connection components mounted on 60 x 45 cm panel*
- ◆ Poolsaver Tetra  
*Poolsaver Tetra*
- ◆ Elektrot akış hücresi  
*Electrode flow cell*
- ◆ İki adet 5 L / 5 Bar Nano dozaj pompası  
*Two 5 L / 5 Bar Nano dosing pumps*
- ◆ El pH elektrodu ve EL ORP elektrodu  
*EL electrode and EL ORP electrode*

MALZEME CİNSİ <i>DESCRIPTON</i>	KOD NO: <i>CODE NO:</i>	FİYATI (€) <i>PRICE</i>	AMBALAJ <i>PACKAGE</i>
SYSTEM 03 Yüzme Havuzu Otomatik Kontrol Sistemi Komple (2 Adet 5 litre / 5 Bar Nano Dozaj Pompası dahildir) <i>SYSTEM 03 Swimming Pool Automatic Control System (Complete)</i> (2 Units 5 liter / 5 Bar Nano Dosing Pumps are included)	HKS-101	1115.00	1 ADET <i>1 UNIT</i>

**NOZBART®**dezenfeksiyon sistemleri  
*disinfection systems***OTOMATİK KONTROL 02**  
**AUTOMATIC CONTROL 02****YÜZME HAVUZU OTOMATİK KONTROL SİSTEMLERİ DOZAJ POMPASIZ**  
**SWIMMING POOL AUTOMATIC CONTROL SYSTEMS WITHOUT DOSING PUMPS**

- ◆ 60 X 90 cm panel üzerinde bağlantı elamanları monte edilmiş halde  
*All connection components mounted on 60 x 90 cm panel*
- ◆ Poolsaver Tetra  
*Poolsaver Tetra*
- ◆ Pislik tutucu ön filtre, elektrot akış hücresi  
*Dirt keeper front filter, electrode flow cell*
- ◆ Numune alma vanası  
*Sample taking valve*
- ◆ Kombine EL pH1 ve EL ORP1 elektrotlar  
*Used combine electrodes EL pH1 ve EL ORP1*



MALZEME CİNSİ DESCRIPTON	KOD NO: CODE NO:	FİYATI (€) PRICE	AMBALAJ PACKAGE
SYSTEM 02 Yüzme Havuzu Otomatik Kontrol Sistemi (Dozaj Pompası dahil değildir) <i>SYSTEM 02 Swimming Pool Automatic Control Systems (Dosing Pump is not included)</i>	HKS-200	<b>1020,00</b>	1 ADET 1 UNIT

**YÜZME HAVUZU OTOMATİK KONTROL SİSTEMLERİ DOZAJ POMPALI**  
**SWIMMING POOL AUTOMATIC CONTROL SYSTEMS WITH DOSING PUMPS**

- ◆ 60 X 90 cm panel üzerinde bağlantı elamanları monte edilmiş halde  
*All connection components mounted on 60 x 90 cm panel*
- ◆ Poolsaver Tetra  
*Poolsaver Tetra*
- ◆ Pislik tutucu ön filtre, elektrot akış hücresi  
*Dirt keeper front filter, electrode flow cell*
- ◆ Numune alma vanası  
*Sample taking valve*
- ◆ Kombine EL pH1 ve EL ORP1 elektrotlar  
*Used combine electrodes EL pH1 ve EL ORP1*

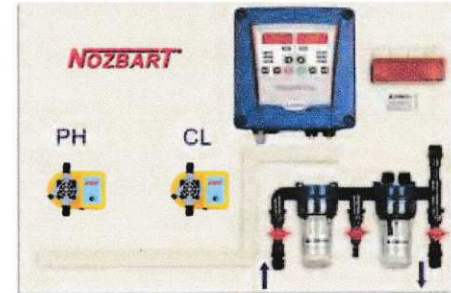

MALZEME CİNSİ DESCRIPTON	KOD NO: CODE NO:	FİYATI (€) PRICE	AMBALAJ PACKAGE
SYSTEM 02 Yüzme Havuzu Otomatik Kontrol Sistemi Komple (2 Adet 5 litre / 7 Bar Nozbart Dozaj Pompası dahildir) <i>SYSTEM 02 Swimming Pool Automatic Control System (Complete) (2 Units 5 litre / 7 Bar Nozbart Dosing Pumps are included)</i>	HKS-201	<b>1390,00</b>	1 ADET 1 UNIT

dezenfeksiyon sistemleri  
disinfection systems

NOZBART®

OTOMATİK KONTROL 01  
AUTOMATIC CONTROL 01YÜZME HAVUZU OTOMATİK KONTROL SİSTEMLERİ DOZAJ POMPASIZ  
SWIMMING POOL AUTOMATIC CONTROL SYSTEMS WITHOUT DOSING PUMPS

- ◆ RS485 bağlantı portu ile bilgisayar, gösterge panelleri, ve yazıcı modülü ile doğrudan haberleşme.  
*RS485 port allows computer connection, the indicator panel, and direct communication with the printer module.*
- ◆ 60 X 90 cm panel üzerinde bağlantı elamanları monte edilmiş halde  
*All connection components mounted on 60 x 90 cm panel*
- ◆ Aqua Control pH - ORP1  
*Aqua Control pH - ORP1*
- ◆ Pislik tutucu ön filtre, elektrot akış hücresi  
*Dirt keeper front filter, electrode flow cell*
- ◆ Numune alma vanası  
*Sample taking valve*
- ◆ Kombine EL pH1 ve EL ORP1 elektrotlar  
*Used combine electrodes EL pH1 ve EL ORP1*

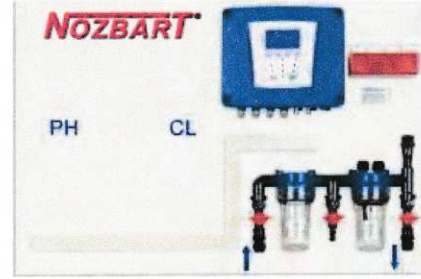

MALZEME CİNSİ DESCRIPTON	KOD NO: CODE NO:	FİYATI (€) PRICE	AMBALAJ PACKAGE
SYSTEM 01 Yüzme Havuzu Otomatik Kontrol Sistemi (Dozaj Pompası dahil değildir) SYSTEM 01 Swimming Pool Automatic Control Systems (Dosing Pump is not included)	HKS-300	1302,00	1 ADET 1 UNIT

YÜZME HAVUZU OTOMATİK KONTROL SİSTEMLERİ DOZAJ POMPALI  
SWIMMING POOL AUTOMATIC CONTROL SYSTEMS WITH DOSING PUMPS

- ◆ RS485 bağlantı portu ile bilgisayar, gösterge panelleri, ve yazıcı modülü ile doğrudan haberleşme.  
*RS485 port allows computer connection, the indicator panel, and direct communication with the printer module.*
- ◆ 60 X 90 cm panel üzerinde bağlantı elamanları monte edilmiş halde  
*All connection components mounted situation on 60 x 90 cm panel*
- ◆ Aqua Control pH - ORP1  
*Aqua Control pH - ORP1*
- ◆ Pislik tutucu ön filtre, elektrot akış hücresi  
*Dirt keeper prefilter, electrode flow cell*
- ◆ Numune alma vanası  
*Sampling valve*
- ◆ Kombine EL pH1 ve EL ORP1 elektrotlar  
*Combine EL pH1 ve EL ORP1 electrodes*



MALZEME CİNSİ DESCRIPTON	KOD NO: CODE NO:	FİYATI (€) PRICE	AMBALAJ PACKAGE
SYSTEM 01 Yüzme Havuzu Otomatik Kontrol Sistemi Komple (2 Adet 5 litre / 7 Bar Nozbart Dozaj Pompası dahildir) SYSTEM 01 Swimming Pool Automatic Control System (Complete) (2 Units 5 litre / 7 Bar Nozbart Dosing Pumps are included)	HKS-301	1672,00	1 ADET 1 UNIT



**NOZBART®**dezenfeksiyon sistemleri  
*disinfection systems***OTOMATİK KONTROL SERBEST CL**  
**AUTOMATIC CONTROL FREE CL****YÜZME HAVUZU OTOMATİK KONTROL SİSTEMLERİ DOZAJ POMPASIZ**  
**SWIMMING POOL AUTOMATIC CONTROL SYSTEMS WITHOUT DOSING PUMPS**

- ◆ RS485 bağlantı portu ile bilgisayar, gösterge panelleri, ve yazıcı modülü ile doğrudan haberleşme.  
*RS485 port allows computer connection, the indicator panel, and direct communication with the printer module.*
- ◆ 60 X 90 cm panel üzerinde bağlantı elamanları monte edilmiş halde  
*All connection components mounted on 60 x 90 cm panel*
- ◆ Aqua Control pH - CL1  
*Aqua Control pH - CL1*
- ◆ Pislik tutucu ön filtre, elektrot akış hücresi  
*Dirt keeper front filter, electrode flow cell*
- ◆ Numune alma vanası  
*Sample taking valve*
- ◆ Ampermetrik serbest klor hücresi, pH elektrodu  
*Ampermetrik free chlorine cell, pH electrode*

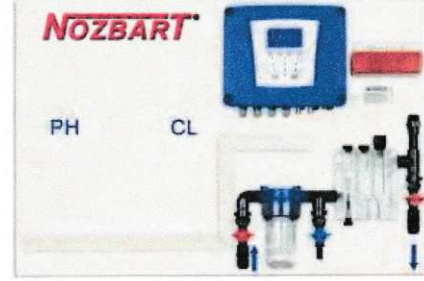

MALZEME CİNSİ DESCRIPTON	KOD NO: CODE NO:	FİYATI (€) PRICE	AMBALAJ PACKAGE
SYSTEM Free CL Yüzme Havuzu Otomatik Kontrol Sistemi (Dozaj Pompası dahil değildir) <i>SYSTEM Free CL Swimming Pool Automatic Control Systems (Dosing Pump is not included)</i>	HKS-400	<b>2962,00</b>	1 ADET 1 UNIT

**YÜZME HAVUZU OTOMATİK KONTROL SİSTEMLERİ DOZAJ POMPALI**  
**SWIMMING POOL AUTOMATIC CONTROL SYSTEMS WITH DOSING PUMPS**

- ◆ RS485 bağlantı portu ile bilgisayar, gösterge panelleri, ve yazıcı modülü ile doğrudan haberleşme.  
*RS485 port allows computer connection, the indicator panel, and direct communication with the printer module.*
- ◆ 60 X 90 cm panel üzerinde bağlantı elamanları monte edilmiş halde  
*All connection components mounted situation on 60 x 90 cm panel*
- ◆ Aqua Control pH - CL1  
*Aqua Control pH - CL1*
- ◆ Pislik tutucu ön filtre, elektrot akış hücresi  
*Dirt keeper prefilter, electrode flow cell*
- ◆ Numune alma vanası  
*Sampling valve*
- ◆ Ampermetrik serbest klor hücresi, pH elektrodu  
*Ampermetrik free chlorine cell, pH electrode*

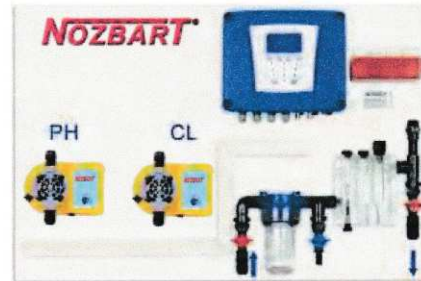

MALZEME CİNSİ DESCRIPTON	KOD NO: CODE NO:	FİYATI (€) PRICE	AMBALAJ PACKAGE
SYSTEM Free CL Yüzme Havuzu Otomatik Kontrol Sistemi Komple (2 Adet 5 litre / 7 Bar Nozbart Dozaj Pompası dahildir) <i>SYSTEM Free CL Swimming Pool Automatic Control System (Complete) (2 Units 5 litre / 7 Bar Nozbart Dosing Pumps are included)</i>	HKS-401	<b>3372,00</b>	1 ADET 1 UNIT

dezenfeksiyon sistemleri  
disinfection systems

NOZBART®

KONTROL VE DÖNÜŞTÜRÜCÜ CİHAZLAR  
CONTROL AND TRANSFORMER EQUIPMENTS

MALZEME CİNSİ DESCRIPTORN	KOD CODE	FİYATI (€) PRICE	AMBALAJ PACKAGE
Poolsaver Tetra (PH / ORP Kontrol Cihazı) Poolsaver Tetra (PH / ORP Control Equipment)	KDC-01	458,00	1 ADET 1 UNIT

Dijital pH (0,00-14,00) , ORP (redox) (0-1000mV) ölçüm ve kontrol cihazıdır.  
Digital pH (0,00 – 14,00) , ORP (0000-1000mV) measurement and control device

Tampon sıvılar kullanılarak ayar çubuğu, tornavida vb. gerektirmeden tamamen dijital ayarlama ve otomatik kalibrasyon.

Completely digital adjustment and automatic calibration by using buffer solutions thus eliminates the needs to use screwdriver or any other tools.

Oransal kontrol özelliği sayesinde her ebattaki yüzme havuzları için ideal çözüm  
It is an ideal solution for every size of swimming pools with proportional control

Aşındırıcı kimyasallara karşı yüksek dayanıklılık sağlayan IP65 plastik gövde  
IP65 plastic body enclouse guarantee durable against to used corrosive chemicals

Kullanıcı şifresi  
User password



MALZEME CİNSİ DESCRIPTORN	KOD CODE	FİYATI (€) PRICE	AMBALAJ PACKAGE
AQUA METER PH1 (PH Kontrol Cihazı-Ops NTC) AQUA METER PH1 (PH Control Equipment - Ops NTC)	KDC-02	369,60	1 ADET 1 UNIT

pH (0,00 – 14,00) ölçüm ve dönüştürme cihazıdır.



MALZEME CİNSİ DESCRIPTORN	KOD CODE	FİYATI (€) PRICE	AMBALAJ PACKAGE
AQUA METER ORP (ORP Kontrol Cihazı) AQUA METER ORP (ORP Control Equipment)	KDC-03	369,60	1 ADET 1 UNIT

ORP (0-1000mV) ölçüm ve dönüştürme cihazıdır.  
ORP (0-1000mV) measurement and control device.

ORP (Oksidasyon İndirgeme Potansiyeli)  
ORP (Oxidation Reduction Potential)



MALZEME CİNSİ DESCRIPTORN	KOD CODE	FİYATI (€) PRICE	AMBALAJ PACKAGE
AQUA METER CON 1 NTC'li iletkenlik kontrol cihazı AQUA METER CON 1 Conductivity Control Device with NTC	KDC-04	369,60	1 ADET 1 UNIT

İletkenlik (0,01 – 10,00 mS) ölçüm ve dönüştürme cihazıdır.  
Conductivity (0,01-10,00) measurement and control device.

ELEKTROTLAR  
ELECTRODES

MALZEME CİNSİ DESCRIPTORN	KOD NO: CODE NO:	FİYATI (€) PRICE	AMBALAJ PACKAGE
Kombine Ph Elektrodu (1,5 M Kablololu) Combine Ph Electrode (1 M Cable)	ELK-PH1	159,60	1 ADET 1 UNIT
Kombine Ph Elektrodu (6 M Kablololu) Combine Ph Electrode (6 M Cable)	ELK-PH6	176,40	1 ADET 1 UNIT
Kombine ORP Elektrodu (1,5 M Kablololu) Combine ORP Electrode (1 M Cable)	ELK-OR1	159,60	1 ADET 1 UNIT
Kombine ORP Elektrodu (6 M Kablololu) Combine ORP Electrode (6 M Cable)	ELK-OR6	176,40	1 ADET 1 UNIT

**NOZBART®**

dezenfeksiyon sistemleri  
*disinfection systems*

**KALİBRASYON SIVISI**  
**BUFFER SOLUTION**

MALZEME CİNSİ DESCRIPTION	KOD NO: CODE NO:	FİYATI PRICE (€)	AMBALAJ PACKAGE
İletkenlik Kalibrasyon Sıvısı 1413 OS Conductivity Buffer Solution 1413 OS	KAL-01K	5,10	20 ml.
	KAL-01B	31,50	480 ml.
İletkenlik Kalibrasyon Sıvısı 2764 OS Conductivity Buffer Solution 2764 OS	KAL-02K	5,10	20 ml.
	KAL-02B	31,50	480 ml.
İletkenlik Kalibrasyon Sıvısı 12.880 OS Conductivity Buffer Solution 12.880 OS	KAL-03K	5,10	20 ml.
	KAL-03B	31,50	480 ml.
ORP 225 Kalibrasyon Sıvısı ORP Buffer Solution	KAL-04K	5,10	20 ml.
	KAL-04B	44,10	480 ml.
ORP 475 Kalibrasyon Sıvısı ORP Buffer Solution	KAL-05K	5,10	20 ml.
	KAL-05B	44,10	480 ml.
Ph 4 Kalibrasyon Sıvısı Ph Buffer Solution	KAL-06K	5,10	20 ml.
	KAL-06B	25,20	480 ml.
Ph 7 Kalibrasyon Sıvısı Ph Buffer Solution	KAL-07K	5,10	20 ml.
	KAL-07B	25,20	480 ml.
Ph 10 Kalibrasyon Sıvısı Ph Buffer Solution	KAL-08K	5,10	20 ml.
	KAL-08B	25,20	480 ml.



**YEDEK PARÇALAR**  
**SPARE PARTS**

MALZEME CİNSİ DESCRIPTION	KOD CODE	FİYATI PRICE (€)
Rakor takımı Union Group	YDZ-001	10,00
Emiş çekvalf takımı Suction checkvalve group	YDZ-002	18,50
Elektrod sabitleme rekoru Electrode fixed record	YDZ-003	15,00
Basma çekvalf takımı Injection checkvalve group	YDZ-004	15,00
Dozaj pompası kafa takımı Dosing pump head group	YDZ-005	30,50
Filtre gövdesi Filter body	YDZ-006	22,00
Elektrot tutma sacı Electrode holder plate	YDZ-007	16,80
Yıkanebilir filtre (5inç) Washable filter	YDZ-008	12,00
Diyafram Membrane	YDZ-009	25,00

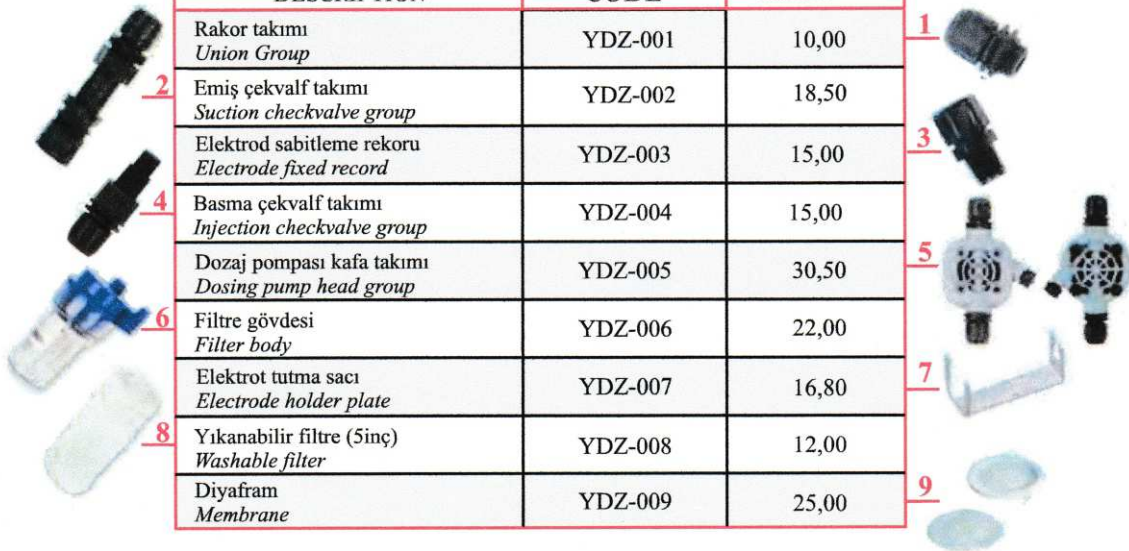

ithal dezenfeksiyon sistemleri  
*imported disinfection systems***NOZBART®****ANALOG DOZAJ POMPALARI**  
**ANALOG DOSING PUMPS**

MALZEME CİNSİ DESCRIPTION	DEBİ FLOW	BASINÇ PRESSURE	KOD CODE	FİYAT (€) PRICE
Dozaj Pompası Dosing pump	2 lt/h	7 bar	DPİ-0207	143,00
Dozaj Pompası Dosing pump	5 lt/h	5 bar	DPİ-0505	143,00

- ◆ Analog kontrollü, Strok hızı ayarlanabilir, PVC kafalı seramik vanalı, seviye kontrollü, emme basma aksesuarları ile birlikte komple set  
Analog dosing pump with constant flow rate, manually adjustable. PVC pump head, Pyrex balls and FPM seals. Level probe input facility.  
Complete installation kit composed by: foot filter, injection valve

**ANALOG DOZAJ POMPALARI**  
**ANALOG DOSING PUMPS**

MALZEME CİNSİ DESCRIPTION	DEBİ FLOW	BASINÇ PRESSURE	KOD CODE	FİYAT (€) PRICE
Dozaj Pompası Dosing pump	10 lt/h	10 bar	DPİ-1010	382,20
Dozaj Pompası Dosing pump	20 lt/h	5 bar	DPİ-0205	499,20

- ◆ Analog kontrollü, Strok hızı ayarlanabilir, 1/5 debi ayarlı, PVDF kafalı, seramik vanalı, emme basma aksesuarları ile birlikte komple set  
Analog dosing pump with constant flow rate. Flow rate manually adjustable, two frequency range (1/5). PVDF pump head, Ceramic balls.  
Complete installation kit composed by: foot filter, injection valve

**DIJİTAL PH VEYA ORP ÖLÇÜM / KONTROL CİHAZLARI**  
**DIGITAL MEASUREMENT / CONTROL INSTRUMENTS (PH OR ORP)**

MALZEME CİNSİ DESCRIPTION	DEBİ FLOW	BASINÇ PRESSURE	KOD CODE	FİYAT (€) PRICE
Dozaj - Ölçüm Seti (PH) Dosage - Measurement Set (PH)	5 lt/h	10 bar	DPHÖ-0510	811,20
Dozaj - Ölçüm Seti (PH) Dosage - Measurement Set (PH)	10 lt/h	10 bar	DPHÖ-1010	912,60
Dozaj - Ölçüm Seti (ORP) Dosage - Measurement Set (ORP)	5 lt/h	10 bar	DORP-0510	811,20
Dozaj - Ölçüm Seti (ORP) Dosage - Measurement Set (ORP)	10 lt/h	10 bar	DORP-1011	912,60

- ◆ Dijital ph veya redoks ölçüm kontrollü, pvdf kafalı, seramik vanalı, seviye kontrollü, toplam çalışma strok sayısı ve debisi alınabilen, kalibrasyon sıvıları, sensörleri ve emme basma aksesuarları ile birlikte  
Digital dosing pump with pH/Redox control meter on board. PVDF pump head, Ceramic balls, Level control input. Flow rate proportional adjustable. Complete installation kit composed by: foot filter, injection valve, and calibration solutions, sensors

**NOZBART®**ithal dezenfeksiyon sistemleri  
*imported disinfection systems***YÜZME HAVUZU DOZLAMA VE KONTROL SİSTEMLERİ**  
**SWIMMING POOL DOSAGE AND CONTROL SYSTEMS**

MALZEME CİNSİ DESCRIPTION	KOD CODE	FİYAT PRICE (€)
<p><b>150 m<sup>3</sup> lük havuzlar için (ph-klor dozaj sistemi)</b> <b>For 150 m<sup>3</sup> pool ( ph- chlorine dosing system)</b></p> <p>Dijital göstergeli, aşırı dozlama alarmlı, 2 ad. peristaltik 5 lt/h 1.5 bar peristaltik pompalı, pH sensörü, ORP sensörü, sensör tutucuları ve kalibrasyon sıvıları ile tedarik edilen pH/ORP ölçüm kontrol ve dozaj sistemi <i>Digital display, over-dosing with alarm, 2 pcs peristaltic 5 l / h 1.5 bar peristaltic pump, pH sensor, ORP sensor, sensor holders and are supplied with calibration liquids of pH / ORP measurement control and dosing system</i></p>	HKSİ-101	988,00
<p><b>500 m<sup>3</sup> lük havuzlar için (ph-klor dozaj sistemi)</b> <b>For 500 m<sup>3</sup> pool ( ph- chlorine dosing system)</b></p> <p>Mikroprosesörlü, dijital pH ve ORP göstergeli, Ip65 korumalı, pH ve ORP sensörlü, otomatik kalibrasyonlu, izoleli,4-20 mA sinyal çıkışlı, 2 adet analog Invikta KCL633 5lt/h 5 bar üstünde monte edilmiş, pH/ORP sensörleri, özel filtrelili bardak tipi sensör tutucuları ve kalibrasyon solüsyonları ile tedarik edilen pH/ORP ölçüm onrol ve dozaj sistemi <i>Microprocessor, a digital pH and ORP display, IP65 protected, pH and ORP sensor, automatic calibration, isolated 4-20 mA signal output, 2 analog dosing pumps Invikta KCL633 5lt / h, 5 bar mounted on. pH / ORP measurement control and dosing system is supplied with pH / ORP sensors, a special filter cup sensor holders and calibration solutions</i></p>	HKSİ-102	1066,00
<p><b>1000 m<sup>3</sup> lük havuzlar için (ph-klor dozaj sistemi)</b> <b>For 1000 m<sup>3</sup> pool ( ph- chlorine dosing system)</b></p> <p>Mikroprosesörlü, dijital pH ve ORP göstergeli, Ip65 korumalı, pH ve ORP sensörlü, otomatik kalibrasyonlu, izoleli,4-20 mA sinyal çıkışlı, 2 adet analog Tekna Evo AKS800NHPO PVDF kafalı, seramik vanalı, 10lt/h 10 bar(18lt/h 1bar) üstüne monte edilmiş, komple pH ve ORP ölçüm &amp; kontrol ve kimyasal dozaj sistemi pH &amp;ORP sensör tutucusu ve solüsyon dahildir. <i>Microprocessor, a digital pH and ORP display, IP65 protected, pH and ORP sensor, automatic calibration, isolated 4-20 mA signal output, 2 analog dosing pumps Tekna Evo AKS800NHPO pump, PVDF head, ceramic valve, 10lt / h, 10 bar (18lt / h 1BAR) had been installed over them. Complete pH and ORP measurement &amp; control and chemical dosing system. pH &amp; ORP sensors, sensor holder and the solution is included.</i></p>	HKSİ-103	1690,00
<p><b>2000 m<sup>3</sup> lük havuzlar için (ph-klor dozaj sistemi)</b> <b>2000 m<sup>3</sup> lük havuzlar için 8ph-klor dozaj sistemi)</b></p> <p>Mikroprosesörlü, dijital pH ve ORP göstergeli, Ip65 korumalı, pH ve ORP sensörlü, otomatik kalibrasyonlu, izoleli,4-20 mA sinyal çıkışlı, 2 adet analog Tekna Evo AKS803NHPO PVDF kafalı, seramik vanalı, 20lt/h 5 bar(50lt/h 1bar) üstüne monte edilmiş, komple pH ve ORP ölçüm &amp; kontrol ve kimyasal dozaj sistemi pH &amp;ORP sensör tutucusu ve solüsyon dahildir. <i>Microprocessor, a digital pH and ORP display, IP65 protected, pH and ORP sensor, automatic calibration, isolated, 4-20 mA output signal. 2 analog dosing pumps TeknaEvo AKS803NHPO PVDF head, ceramic valve, 20lt / h, 5 bar (50lt / h 1BAR) was mounted over them. complete pH and ORP measurement &amp; control and chemical dosing system. pH &amp; ORP sensors, sensor holder and the solution is included.</i></p>	HKSİ-104	1859,00

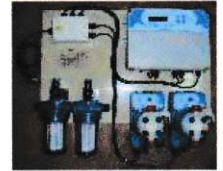







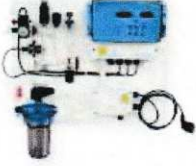
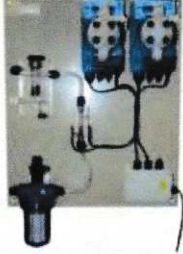
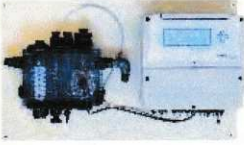

ithal dezenfeksiyon sistemleri  
imported disinfection systems

NOZBART®

ENDÜSTRİYEL HAVUZ SİSTEMLERİ  
INDUSTRIAL POOL SYSTEMS

MALZEME CİNSİ DESCRIPTION	KOD CODE	FİYAT PRICE (€)
 <p>Mikroprosesörlü, dijital bakiye klor ve pH göstergeli, yıkanabilir filtrelü, otomatik temizlemeli Pt/Cu klor sensörlü, pH sensörü dahil, izoleli, Ip65 korumalı, 4-20 mA sinyal çıkışlı, RS485 seri portlu data transfer çıkışlı, ppm olarak bakiye klor ölçüm &amp; kontrol sistemi (pH 0-14, Cl2 0-5 mg/l)</p> <p><i>Microprocessor, a digital residual chlorine and pH display, washable filter, automatic cleaning of Pt / Cu, including chlorine sensor and pH sensor. Isolated, IP65 protected, 4-20 mA signal output, RS485 serial port data from the transfer. ppm of residual chlorine measurement &amp; control system (pH 0-14, 0-5 Cl2 mg / l)</i></p>	HKSİ-201	2860,00
 <p>Mikroprosesörlü, dijital pH ve serbest klor (0-10 ppm) göstergeli Ip65 korumalı, pH ve serbest klor sensörlü, otomatik kalibrasyonlu izoleli, 4-20 mA sinyal çıkışlı, 2 adet dijital oransal Tekna TMP603 5lt/h 10 bar, PVDF kafalı üstünde monte edilmiş, komple pH ve serbest klor ölçüm &amp; kontrol ve kimyasal dozaj sistemi pH &amp; serbest klor sensörler, sensör tutucusu ve solüsyon dahildir.</p> <p><i>Microprocessor, a digital pH and free chlorine (0-10 ppm), display, IP65 protected, pH and free chlorine sensor, automatic calibration, isolated 4-20 mA signal output, 2 digital proportional dosing pumps Tekna TMP603 5lt / h, 10 bar, PVDF head, mounted on a complete pH and free chlorine measurement &amp; control and chemical dosing system. pH &amp; free chlorine sensors, sensor holder and the solution is included</i></p>	HKSİ-202	3900,00
 <p>Mikroprosesörlü, dijital pH, redoks, serbest klor göstergeli, 2 tane kuru kontak ve 4 adet 4-20 MA sinyal çıkışlı, RS485 seri portlu data transfer çıkışlı ölçüm kontrol sistemi</p> <p><i>Microprocessor, digital, ph, redox, free chlorine indicator, the measurement control system. 2 pcs contact and 4 pcs 4-20 MA signal output, RS485 serial port for data</i></p>	HKSİ-203	4394,00

YEDEK PARÇALAR  
SPARE PARTS

MALZEME CİNSİ DESCRIPTION	KOD CODE	FİYAT PRICE (€)
 <p>6m. kablolu, 60 °C ye kadar çalışabilen epoksi PH sensörü <i>6m. cable, epoxy pH sensor can operate up to 60 ° C</i></p>	YDZİ-01	114,40
 <p>6m. kablolu, 60 °C ye kadar çalışabilen epoksi ORP sensörü <i>6m. cable, epoxy ORP sensor can operate up to 60 ° C</i></p>	YDZİ-02	122,20
 <p>By-pass hattı üzerine monte edilen, filtrelü sensör tutucu <i>Mounted on the by-pass line, sensor holder with filter</i></p>	YDZİ-03	59,80
 <p>Boruya montaj tipi sensör tutucu <i>Pipe assembly-type sensor holder</i></p>	YDZİ-04	10,40
 <p>50 cc PH 4 kalibrasyon solüsyonu <i>50 cc PH 4 buffer solution</i></p>	YDZİ-05	10,40
 <p>50 cc PH 7 kalibrasyon solüsyonu <i>50 cc PH 7 buffer solution</i></p>	YDZİ-06	10,40
 <p>465 mV ORP kalibrasyon solüsyonu <i>465 mV ORP buffer solution</i></p>	YDZİ-07	15,60
 <p>Pompaların kuru çalışmasını engellemek için seviye sensörü <i>Level sensor for prevent to pumps running dry</i></p>	YDZİ-08	31,20

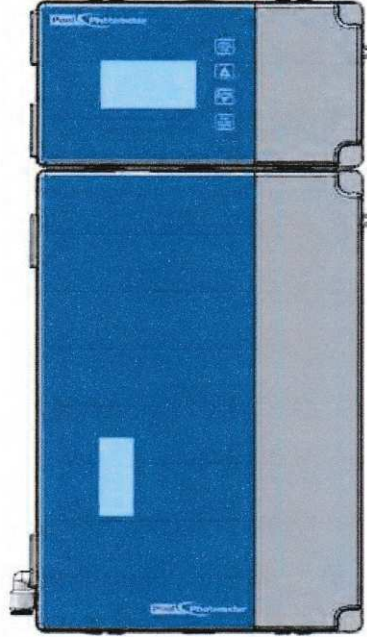
**NOZBART®**ithal dezenfeksiyon sistemleri  
*imported disinfection systems***FOTOMETRİK ÖLÇÜM CİHAZI**  
**PHOTOMETRIC MEASUREMENT DEVICE**

MALZEME CİNSİ DESCRIPTION	KOD CODE	FİYAT (€) PRICE
<b>Fotometrik Ölçüm Cihazı</b> pH, serbest klor ölçümlü, analog ve digital çıkışlı, fotometre ölçüm sistemi <b>Photometric Measurement Device</b> pH, free chlorine measurements, analog and digital outputs, the photometer measurement system	HKFÖ-001	4160,00